

BASO 4.0 DIRECT



Catalog Number Example

BASO 4.0-SAT-BL-OP-30K-C80-UNV-010V-SEN-955LF-NLC-ST-96IN

A RANGE

BASO 4.0 B A S O 4 . 0

B MOUNTING

QS Surface S U R
 Surface in-line ACT T-BAR S A T
 Surface in-line ACT SLOT S A S
 Surface ACT center tile S A C
QS Pendant P D T
 Pendant in-line ACT T-BAR P A T
 Pendant in-line ACT SLOT P A S
 Pendant ACT center tile P A C

pendant suspension set includes cable suspension and one white power feeder with a white junction box cover

Wall mounted W A L

for black power feeds or junction box covers, please contact customer service

I SENSOR (optional)

Integrated Sensor S E N
 consult customer service for sensor request

J OUTPUT LM/FT

QS 500lm/ft 100% ↓ 0 5 0 0 L F
QS 750lm/ft 100% ↓ 0 7 5 0 L F
QS 1000lm/ft 100% ↓ 1 0 0 0 L F
 Custom lm/ft X X X X L F
custom lumen up to 1400 lm/ft

K CIRCUIT / EM

QS Single circuit *
 EMC night light circuit N L C
 EMB available in 4ft and 8ft E M #
 *leave blank

C COLOR

QS White W H
QS Black B L
 Gray G R
 Custom color RAL X X

trimless version available in white only

L SHAPE / PATTERN

QS Linear / straight S T
QS Linear / straight + flex inset S F
 includes 1ft. field-cutttable section; only available for 4' and 8' segments
 L-shape L S
 □-shape (rectangular shape) R S
 U-shape U S
 Custom shape X X

D LENS

HP opal cover O P

E CCT

2700K 2 7 K
QS 3000K 3 0 K
QS 3500K 3 5 K
 4000K 4 0 K

M DIMENSIONS IN INCH

Linear 2' 2 4 I N
QS Linear 4' 4 8 I N
QS Linear 6' 7 2 I N
QS Linear 8' 9 6 I N
 Linear custom # # # I N
 Linear flex inset # # # I N
 includes 4' to 3' field-cutttable section
 L-Shape # # # X # # # I N
 U-Shape # # # X # # # X # # # I N
 □-Shape # # # X # # # I N

for lengths including flex insets, round up to the nearest **total** foot length

F CRI

CRI > 80 C 8 0
 CRI > 90 C 9 0

G VOLTAGE

120V/277V U N V

H DIMMING

QS 0-10V 1% 0 1 0 V
 Lutron EcoSystem L E S 1
 Quantum, Vive, GRAFIK Eye, HomeWorks
 Power over ethernet P O E C
 consult customer service for compatibility
 Custom dimming X X X X
 consult customer service for compatibility

N CERTIFICATION (optional)

Red List Approved R L A

PERFORMANCE

- Up to 111lm/W efficiency
- 500 / 955 lm/ft
- CRI > 80 & CRI > 90
- Damp rated

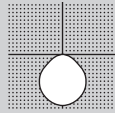

MOUNTING

Ceiling

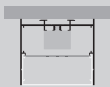

Wall



Pendant



PATTERNS



*X Shapes



Angular



*Wall to Ceiling



Rectangular



*T Shapes

For customization, please contact customer service

FIELD-CUTTABLE FLEX

Down to 1/16"



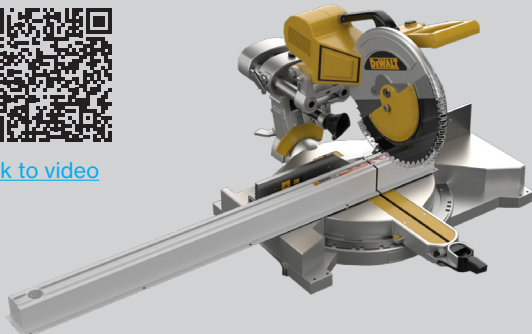

[link to video](#)



BASO
 basolighting.com
 xalusa.com

Technical data

	SIZE TYPE	LED COLOR TEMPERATURE	INPUT WATTS	DELIVERED LM TOTAL	LIGHT DISTRIBUTION	DELIVERED LM DIRECT	DELIVERED LM INDIRECT	OPTICAL EFFICIENCY	LUMINAIRE EFFICACY	
BASO DIRECT										
	e LED	2' linear	40K	9W	910lm	100% down	500lm/ft	-	76%	111lm/W
		4' linear		18W	2000lm					
		6' linear		27W	3000lm					
		8' linear		36W	4000lm					
		2' + 2' corner		18W	2000lm					
	e ² LED	2' linear	40K	18W	1920lm	100% down	955lm/ft	-	76%	106lm/W
		4' linear		36W	3840lm					
		6' linear		54W	5730lm					
		8' linear		72W	7680lm					
		2' + 2' corner		36W	3840lm					

for 30 K or 35 K multiply lm value by 0.96

Patterns top view

LINEAR

A	FIXTURES	CODE
48"	1 × 4' linear	ST - 0 4 FT
96"	1 × 8' linear	ST - 0 8 FT
144"	3 × 4' linear	ST - 1 2 FT

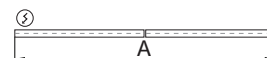

L-SHAPE

A / B	FIXTURES	CODE
48" / 48"	2 × 2' linear + 1 × 2' × 2' corner	LS - 0 4 X 0 4 FT
48" / 96"	1 × 2' linear + 1 × 6' linear + 1 × 2' × 2' corner	LS - 0 4 X 0 8 FT
96" / 96"	2 × 6' linear + 1 × 2' × 2' corner	LS - 0 8 X 0 8 FT

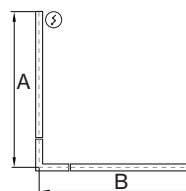

□-SHAPE (rectangular shape)

A / B	FIXTURES	CODE
48" / 48"	4 × 2' × 2' corner	RS - 0 4 X 0 4 FT
48" / 96"	2 × 4' linear + 4 × 2' × 2' corner	RS - 0 4 X 0 8 FT
96" / 96"	4 × 4' linear + 4 × 2' × 2' corner	RS - 0 8 X 0 8 FT

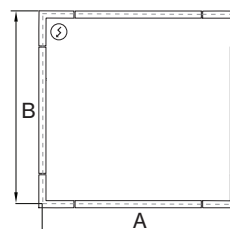

U-SHAPE

A / B / C	FIXTURES	CODE
48" / 48" / 48"	2 × 2' linear + 2 × 2' × 2' corner	US - 0 4 X 0 4 X 0 4 FT
48" / 96" / 48"	1 × 4' linear + 2 × 2' linear + 2 × 2' × 2' corner	US - 0 4 X 0 8 X 0 4 FT
48" / 144" / 48"	1 × 8' linear + 2 × 2' linear + 2 × 2' × 2' corner	US - 0 4 X 1 2 X 0 4 FT

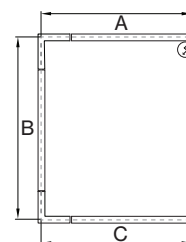

DIMENSIONS

BASO 4.0

SURFACE direct

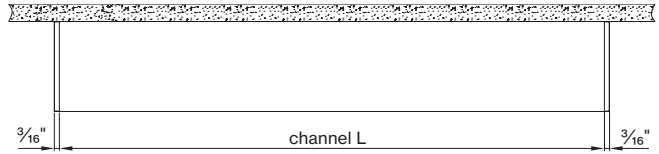
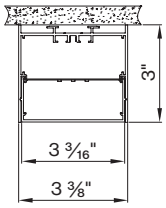

PENDANT

direct

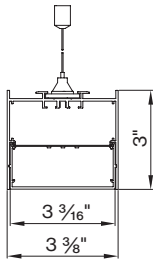

direct / indirect

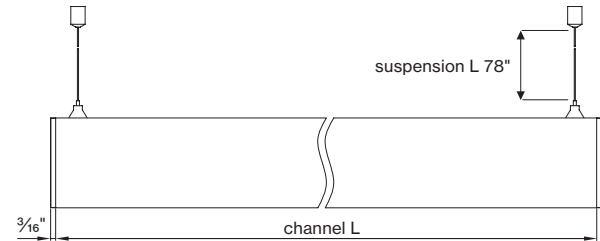
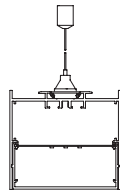

BASO 4.0 SPECIALITY MOUNTING

SURFACE
in-line ACT TBAR

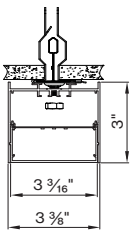

SURFACE
in-line ACT SLOT

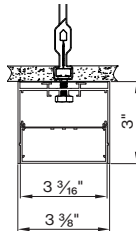

SURFACE
ACT center tile

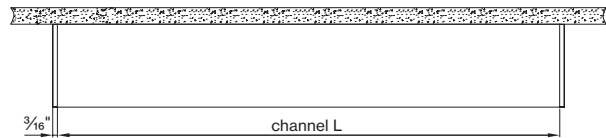
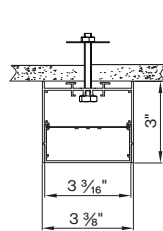

PENDANT
ACT TBAR

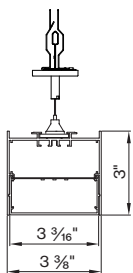

PENDANT
in-line ACT SLOT

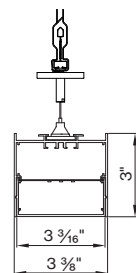

PENDANT
ACT center tile

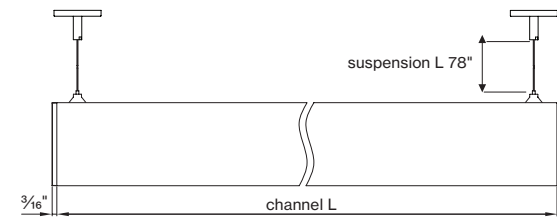
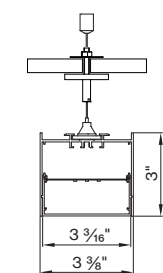

Declare.

BASO 11 23 4.0
XAL USA Incorporated
First Assembly: China, Connecticut, USA
Last Assembly: Mexico
Date of Last Update: 02/14/2023 (V10.0, Lantini/ENR)
Intention:
This document is intended to provide information and guidance for the installation and use of the product. It is not intended to be a contract or a warranty. The user is responsible for ensuring that the product is installed and used in accordance with the instructions and specifications provided in this document.
Use Intended:
This document is intended for use by installers and users of the product. It is not intended for use by anyone else.
Use Intended:
This document is intended for use by installers and users of the product. It is not intended for use by anyone else.
Use Intended:
This document is intended for use by installers and users of the product. It is not intended for use by anyone else.
Use Intended:
This document is intended for use by installers and users of the product. It is not intended for use by anyone else.

BASO mounting instructions

Get access to the BASO 4.0 mounting instructions faster by scanning the QR code.

www.xalusa.com/resources/mounting-instructions/baso

